

Vaporox

with VHT™

VHT-200

Wound Treatment System

USER MANUAL



⚠ IMPORTANT ⚠

Caution: Federal law restricts this device to be used by or on the order of a physician. Before using the VHT-200, read this manual and follow the operating instructions carefully.

Some photos in the user's manual may vary depending on the use of the machine.

Copyright © 2023 Vaporox, Inc. All rights reserved. This manual may not be copied, photocopied, reproduced, translated, or converted to any electronic or machine-readable form in whole or in part without prior written approval of Vaporox. Non-authorized reproduction or modification of this manual is a violation of the proprietary rights of Vaporox as copyright owner.

PN 10-0044, Rev 08 Nov 2022

Table of Contents

Safety Symbols	1
Glossary	2
General Description	3
Intended Use of the VHT-200 Wound Treatment System	3
Contraindications.....	4
Description of System and Accessories.....	4
Requirements.....	4
Technical Description	5
VHT-200 Classification & Specifications.....	5
Environment.....	6
Environmental Conditions for Storage and Transport	6
Environmental Conditions for Operation	6
Warnings.....	12
Precautions	15
Potential Risks and Benefits.....	15
Patient Sensitivities.....	15
Questions?	16
Overview of the VHT-200 System	17
Equipment Description:	18
Control Panel:.....	19

Power:.....	19
Preparing for Treatment	20
Starting Treatment	26
After Treatment Care.....	28
Cleaning of the VHT-200.....	29
Equipment, Basin, Pole Cleaning Solutions	29
Equipment, Basin, Pole Cleaning Process	29
Vaporizer Cleaning Solutions.....	29
Vaporizer Cleaning Process.....	29
Transport & Storage	32
Maintenance.....	34
Troubleshooting.....	35
Contacting Vaporox Technical Service.....	37
WARRANTY	38

Safety Symbols

THE PURPOSE OF SAFETY SYMBOLS IS TO ATTRACT YOUR ATTENTION TO POSSIBLE DANGERS. THE SAFETY SYMBOLS, AND THE EXPLANATIONS WITH THEM, DESERVE CAREFUL ATTENTION AND UNDERSTANDING.

SAFETY SYMBOL MEANINGS



Safety Alert – Indicates danger, warning, or caution.



Universal No Smoking Sign



Shock Hazard – Indicates the presence of electric shock hazards.



WARNING: Read the User's Manual with the Wound Treatment System. Failure to follow operating instructions and safety precautions in User's Manual can result in injury.



Type B applied part



DANGER – May cause or intensify fire. An oxidizing material may or may not burn itself, but will release oxygen or another oxidizing substance, and thereby causes or contributes to the combustion of another material. If a fire or spark is detected, immediately turn the on/off switch to the off position, if possible, unplug the equipment from the outlet and evacuate the area.



NOTE: Notes are advisory comments or recommendations regarding practices and procedures.



WARNING: Guard against electric shock hazards. The power cord protective grounding connector must be connected to ground.



TIP HAZARD: A hazard warning refers to a risk of injury or machine damage due to improper handling of equipment.



OVERBALANCE HAZARD: Do not push against the front or back of the system when transporting.



WARNING: A.) Place any electrical appliance at least five feet from the patient. B.) Move equipment or personal items likely to produce static discharges at least five feet from the patient.

Glossary

BASIN – The bottom module, or base, of the VHT 200 system which latches to the Equipment.

CYCLE – Consists of a pre-defined function and duration set by the physician providing the VHT-200 treatment.

DISPLAY – User interface including touchscreen and switches of the VHT-200 control panel.

EQUIPMENT – Primary module of the VHT 200 system which is located and latched to the top of the Basin.

FUNCTION – Any one of the VHT-200 multi-modalities.

MEDICAL PROVIDER – Prescribing physician of the VHT-200.

HYPEROXIA – Oxygen concentration greater than local environment.

OXYGEN – Hyperoxia Treatment.

VHT™ – Vaporous Hyperoxia therapy.

TREATMENT – The application and usage of the VHT-200.

TREATMENT CHAMBER – The single-use, disposable used to contain the treatment environment around the patient's wound.

TREATMENT SOLUTION – Sterile water for irrigation.

VAPORIZER – Provides adiabatic ultrasonic formed vapor.

VHT-200 – Multi-modality wound treatment system.

General Description

The Wound Treatment System (**VHT-200**) is a prescription medical device. This system is designed for most injuries that can benefit from the properties of oxygen and water-based moisture therapy treatments. All the benefits of oxygen and moisture modalities are self-contained into one system and applied without the need of switching applications. The System includes Equipment (a top unit) with a touchscreen user interface, a lower Basin unit, a Vaporizer, a Pole that attaches in the back of the basin unit and provides support for the Treatment Chamber bag with a drawstring and the connecting hose from the vaporizer to the Treatment Chamber Bag to fill with oxygen and vapor. The **VHT-200** is made for clinical use only. The maximum duration for a single treatment is 56 minutes total time, including both oxygen and vapor.

This device cannot, nor is it implied, that the VHT-200 Wound Treatment System, is capable of preventing or curing any disease. This device does not have essential performance and should be considered a part of adjunct therapy for wound treatment.

R_x Only

Caution: Federal law restricts this device to sale by or on the order of a physician.

Intended Use of the VHT-200 Wound Treatment System

The intended use of **VHT-200** is to provide humidified oxygen to open, acute or chronic wounds as an adjunct therapy in wound management and treatment.

The VHT-200 System is intended for the following kinds of wounds:

- Skin ulcerations due to diabetes, venous stasis, post-surgical infections and gangrenous lesions
- Decubitus ulcers
- Amputations / infected stumps
- Skin grafts
- Burns
- Frostbite

Contraindications

Contraindications for the VHT-200 System include:

- Patients with active infections of cellulitis or osteomyelitis in the treated limb
- Patients with diagnosed malignant ulcers in the treated limb
- Not for respiratory use

Description of System and Accessories

The device consists of a main System Unit.

To support the use of the System Unit, the following accessories are needed:

- Basin
- Vaporizer
- Pole (with hose hangers)
- Disposable Treatment Chamber Kit (includes treatment chamber bag, bag support, hose connectors, and treatment hose) which is single use only
- Approved Power Cord
- Sterile Water for Irrigation

Requirements

Operators shall be knowledgeable in the intended use of the system and trained in the clinical environment. In addition, operators of the VHT-200 must be trained to provide treatment at the direction of a physician and the operator should be:

- Proficient in healthcare procedures regarding aseptic techniques
- Thoroughly understanding of the contents of this manual
- Fully trained and qualified to operate this system

Technical Description

VHT-200 Classification & Specifications

VHT-200 System Unit	
Type	Specification
Size (approx.)	16" (D) x 48" (H) x 28" (W)
Weight	130 pounds
Oxygen System Flow Rate	Up to 5 L/minute @ > 85% at STDP (standard temperature and pressure, dry)
Transport and Storage Conditions	-20°C to 60°C (-4°F to 140°F) and Humidity: 0% - 85% (non-condensing)
Operating Conditions	18°C to 29°C (65 °F to 85) °F and Humidity: 0% - 80% (non-condensing) Altitude above sea level: 0 - 3000 meters
Operating Pressure	69 kPa - 101 kPa
Power Supply	120 VAC 60Hz 10A
Display	Touchscreen
Modes of Operation	Continuous
Protection against electric shock	Type: Safety Class I Degree: Type B
Ingress Rating	IPX0 (Not protected)
Fuses	F 10AL 250V
Wireless Communications	FCC ID: 2AEMI-BRN402 Operating Frequency: Cellular 698MHz - 2690MHz (Radiated power 1.15mW)

VHT-200 Disposable Treatment Chamber Kits	
Type	Specification
Size (approx.)	2" (D) x 12" (H) x 18" (W)
Weight	1 pound
Transport and Storage Conditions	-20°C to 60°C (-4°F to 140°F) and Humidity: 0% - 85% (non-condensing)
Operating Conditions	18°C to 29°C (65 °F to 85 °F) and Humidity: 0% - 80% (non-condensing) Altitude above sea level: 0 - 3000 meters

VHT-200 Disposable Treatment Chamber Kits

Type	Specification
Operating Pressure	69 kPa - 101 kPa

Environment

Operation, transport, and storage of the **VHT-200** should be in an environment that meets the following requirements.

Environmental Conditions for Storage and Transport

VHT-200 System Unit

Store indoors or store and transport in an enclosed weather-proof and non-condensing environment.

VHT-200 Disposable Treatment Chamber Kits

Store indoors or store and transport in an enclosed weatherproof and non-condensing environment.

Environmental Conditions for Operation

The **VHT-200** is not weatherproof. Operate indoors or in an enclosed and non-condensing environment. Provide sufficient ventilation to prevent the accumulation of low oxygen concentration gas in the surrounding space such as a room that has airflow (as provided by a typical building HVAC system). Preferred operation conditions include a controlled dry environment.

Cellular Connection

The VHT-200 can connect, via encrypted connection, to a mobile app for system monitoring and diagnostic data. The data monitored is limited to VHT-200 System data and does not contain any patient or provider data. To maintain cybersecurity, do not attempt to connect the VHT-200 System to any wifi networks, computers, or remote connections.

Guidance and manufacturer's declaration – electromagnetic emissions		
The VHT-200 Wound Treatment System is intended for use in the electromagnetic environment specified below. The customer or the user of the VHT-200 Wound Treatment System should assure that it is used in such an environment.		
Emissions test	Compliance	Electromagnetic environment - guidance
RF emissions CISPR 11	Group 1	The VHT-200 Wound Treatment System uses RF energy only for its internal function. Therefore, its RF emissions are very low and are not likely to cause any interference in nearby electronic equipment.
RF emissions CISPR 11	Class A	The VHT-200 Wound Treatment System is suitable for use in all establishments other than domestic, and may be used in domestic establishments and those directly connected to the public low-voltage power supply network that supplies buildings used for domestic purposes, provided the following warning is heeded: Warning: This equipment/system is intended for use by healthcare professionals only. This equipment/system may cause radio interference or may disrupt the operation of nearby equipment. It may be necessary to take mitigation measures, such as re-orienting or relocating the VHT-200 Wound Treatment System or shielding the location.
Harmonic emissions IEC 61000-3-2	Not applicable as the device is only powered at 120V 60Hz	
Voltage Fluctuations IEC 61000-3-3	Not applicable as the device is only powered at 120V 60Hz	

Guidance and manufacturer's declaration – electromagnetic immunity			
The VHT-200 Wound Treatment System is intended for use in the electromagnetic environment specified below. The customer or the user of the VHT-200 Wound Treatment System should assure that it is used in such an environment.			
Immunity test	IEC 60601 test level	Compliance level	Electromagnetic environment - guidance
Electrostatic discharge (ESD) IEC 61000-4-2	± 8 kV contact ± 15 kV air	± 8 kV contact ± 15 kV air	Floors should be wood, concrete or ceramic tile. If floors are covered with synthetic material, the relative humidity should be at least 30%.
Electrical fast transient/burst IEC 61000-4-4	± 2 kV for power supply lines	± 2 kV for power supply lines	Mains power quality should be that of a typical commercial or hospital environment.
Surge IEC 61000-4-5	± 1 kV line(s) to line ± 2 kV line(s) to earth	± 1 kV line(s) to line ± 2 kV line(s) to earth	Mains power quality should be that of a typical commercial or hospital environment.
Voltage dips, short interruptions and voltage variations on power supply input lines IEC 61000-4-11	0 % <i>UT</i> ; 0,5 cycle At 0°, 45°, 90°, 135°, 180°, 225°, 270° and 315° 0 % <i>UT</i> ; 1 cycle and 70 % <i>UT</i> ; 25/30 cycles h) Single phase: at 0° 0 % <i>UT</i> ; 250/300 cycle	0 % <i>UT</i> ; 0,5 cycle At 0°, 45°, 90°, 135°, 180°, 225°, 270° and 315° 0 % <i>UT</i> ; 1 cycle and 70 % <i>UT</i> ; 25/30 cycles h) Single phase: at 0° 0 % <i>UT</i> ; 250/300 cycle	Mains power quality should be that of a typical commercial or hospital environment. If the user of the VHT-200 Wound Treatment System requires continued operation during power mains interruptions, it is recommended that the VHT-200 Wound Treatment System be powered from an uninterruptible power supply or a battery.
Power frequency (50/60 Hz) magnetic field IEC 61000-4-8	30 A/m	30 A/m	Power frequency magnetic fields should be a levels characteristic of a typical location in a typical commercial or hospital environment.
NOTE: U_T is the A.C. mains voltage prior to application of the test level.			

Guidance and manufacturer’s declaration – electromagnetic immunity			
The VHT-200 Wound Treatment System is intended for use in the electromagnetic environment specified below. The customer or the user of the VHT-200 Wound Treatment System should assure that it is used in such an environment.			
Immunity test	IEC 60601 test level	Compliance level	Electromagnetic environment - guidance
Conducted RF IEC 61000-4-6	3 Vrms 0,15 MHz – 80 MHz	3 Vrms 0,15 MHz – 80 MHz	Portable and mobile RF communications equipment should be used no closer to any part of the VHT-200 Wound Treatment System, including cables, than the recommended separation distance calculated from the equation applicable to the frequency of the transmitter. Recommended separation distance $d = [3.5/3] \sqrt{P}$ 80 MHz to 800 MHz $d = [7/3] \sqrt{P}$ 800 MHz to 2.7 GHz where P is the maximum output power rating of the transmitter in watts (W) according to the transmitter manufacturer and d is the recommended separation distance in meters (m). Field strengths from fixed RF transmitters, as determined by an electromagnetic site survey, should be less than the compliance level in each frequency range. Interference may occur in the vicinity of equipment marked with the following symbol: 
	6 Vrms in ISM and amateur radio bands between 0,15 MHz and 80 MHz 80 % AM at 1 kHz	6 Vrms in ISM and amateur radio bands between 0,15 MHz and 80 MHz 80 % AM at 1 kHz	
Radiated RF IEC 61000-4-3	3 V/m 80 MHz to 2.7 GHz	3 V/m 80 MHz to 2.7 GHz	
NOTE 1 At 80 MHz and 800 MHz, the higher frequency range applies. NOTE 2 These guidelines may not apply in all situations. Electromagnetic propagation is affected by absorption and reflection from structures, objects and people.			
<ul style="list-style-type: none"> Field strengths from fixed transmitters, such as base stations for radio (cellular/cordless) telephones and land mobile radios, amateur radio, AM and FM radio broadcast and TV broadcast cannot be predicted theoretically with accuracy. To assess the electromagnetic environment due to fixed RF transmitters, an electromagnetic site survey should be considered. If the measured field strength in the location in which the VHT-200 Wound Treatment System is used exceeds the applicable RF compliance level above, the VHT-200 Wound Treatment System should be observed to verify normal operation. If abnormal performance is observed, additional measures may be necessary, such as re-orienting or relocating the VHT-200 Wound Treatment System. 			

Guidance and manufacturer’s declaration – electromagnetic immunity

<p>The VHT-200 Wound Treatment System is intended for use in the electromagnetic environment specified below. The customer or the user of the VHT-200 Wound Treatment System should assure that it is used in such an environment.</p>			
Immunity test	IEC 60601 test level	Compliance level	Electromagnetic environment - guidance
<p>IMMUNITY to proximity fields from RF wireless communications equipment</p>	<p>MHz – Modulation – Field Strength</p> <p>385 - 18 Hz - 27 V/m 450 - 18 Hz - 28 V/m 710 - 217 Hz - 9 V/m 745 - 217 Hz - 9 V/m 780 - 217 Hz - 9 V/m 810 - 18 Hz - 28 V/m 870 - 18 Hz - 28 V/m 930 - 18 Hz - 28 V/m 1720 - 217 Hz - 28 V/m 1845 - 217 Hz - 28 V/m 1970 - 217 Hz - 28 V/m 2450 - 217 Hz - 28 V/m 5240 - 217 Hz - 9 V/m 5500 - 217 Hz - 9 V/m 5785 - 217 Hz - 9 V/m</p>	<p>MHz – Modulation – Field Strength</p> <p>385 - 18 Hz - 27 V/m 450 - 18 Hz - 28 V/m 710 - 217 Hz - 9 V/m 745 - 217 Hz - 9 V/m 780 - 217 Hz - 9 V/m 810 - 18 Hz - 28 V/m 870 - 18 Hz - 28 V/m 930 - 18 Hz - 28 V/m 1720 - 217 Hz - 28 V/m 1845 - 217 Hz - 28 V/m 1970 - 217 Hz - 28 V/m 2450 - 217 Hz - 28 V/m 5240 - 217 Hz - 9 V/m 5500 - 217 Hz - 9 V/m 5785 - 217 Hz - 9 V/m</p>	<p>Portable and mobile RF communications equipment should be used no closer to any part of the VHT-200 Wound Treatment System, including cables, than the recommended separation distance calculated from the equation applicable to the frequency of the transmitter.</p> <p>Recommended separation distance</p> <p>$E = [6/d] \sqrt{P}$ $d = [6/E] \sqrt{P}$</p> <p>where P is the maximum output power rating of the transmitter in watts (W) according to the transmitter manufacturer, d is the recommended separation distance in meters (m), and E is the field strength in V/m. Field strengths from fixed RF transmitters, as determined by an electromagnetic site survey, should be less than the compliance level in each frequency range. Interference may occur in the vicinity of equipment marked with the following symbol:</p> 
<p>NOTE: These guidelines may not apply in all situations. Electromagnetic propagation is affected by absorption and reflection from structures, objects and people.</p>			

Recommended separation distances between portable and mobile RF communications equipment as well as RF wireless communications equipment the VHT-200 Wound Treatment System.

The VHT-200 Wound Treatment System is intended for use in an electromagnetic environment in which radiated RF disturbances are controlled. The customer or the user of the VHT-200 Wound Treatment System can help prevent electromagnetic interference by maintaining a minimum distance between portable and mobile RF communications equipment (transmitters) and the VHT-200 Wound Treatment System as recommended below, according to the maximum output power of the communications equipment.

Rated maximum output power of transmitter (W)	Separation distance according to frequency of transmitter (m)			
	80 to 800 MHz $d = [3.5/3] \sqrt{P}$	800 MHz to 2.7 GHz $d = [7/3] \sqrt{P}$	710, 745, 780, 5240, 5500, 5785 MHz $d = [6/9] \sqrt{P}$	385, 450, 810, 870, 930, 1720, 1845, 1970, 2450 MHz $d = [6/28] \sqrt{P}$
0.01	0.117	0.233	0.067	0.021
0.1	0.369	0.738	0.211	0.070
1	1.170	2.333	0.667	0.214
10	3.689	7.379	2.108	0.700
100	11.667	23.333	6.670	2.143

For transmitters rated at a maximum output power not listed above, the recommended separation distance d in meters (m) can be estimated using the equation applicable to the frequency of the transmitter, where P is the maximum output power rating of the transmitter in watts (W) according to the transmitter manufacturer.

NOTE 1 At 80 MHz and 800 MHz, the separation distance for the higher frequency range applies.

NOTE 2 These guidelines may not apply in all situations. Electromagnetic propagation is affected by absorption and reflection from structures, objects and people.

NOTE: This equipment has been tested and found to comply with the limits for a Class A digital device, pursuant to part 15 of the FCC Rules. These limits are designed to provide reasonable protection against harmful interference when the equipment is operated in a commercial environment. This equipment generates, uses, and can radiate radio frequency energy and, if not installed and used in accordance with the instruction manual, may cause harmful interference to radio communications. Operation of this equipment in a residential area is likely to cause harmful interference in which case the user will be required to correct the interference at his own expense.

Warnings



WARNING! For treatment of wounds, this device should be used under close supervision and direction of a medical provider.



WARNING! The device is not intended for any use other than indicated.



WARNING! Use of this equipment adjacent to or stacked with other equipment should be avoided because it could result in improper operation. If such use is necessary, this equipment and the other equipment should be observed to verify that they are operating normally.



WARNING! The treatment kit (treatment bag, bag support, hose and hose connectors) is single use only and must be disposed of after treatment is completed.



WARNING! Unattended use of the VHT-200 by children or incapacitated persons may be dangerous.



WARNING! Portable RF communications equipment (including peripherals such as antenna cables and external antennas) should be used no closer than 30 cm (12 inches) to any part of the VHT-200 Wound Treatment System, including cables specified by the manufacturer. Otherwise, degradation of the performance of this equipment could result.



WARNING! Spills and leaks may pose a slip-and-fall hazard. Be cautious about patient slip hazards during patient set up.



WARNING! Failure to install, operate, and maintain this equipment according to Manufacturer's instructions may cause injury.



WARNING! Be careful not to tip the machine when rolling over uneven surfaces. Do not roll machine when filled and in use. Do not push or lean against the machine when wheels are locked.



WARNING! Set wheel locks when system is in use or stored or parked.



WARNING! Do not Lift the System with the Basin and Equipment portion connected using the handles. Such handling may cause damage.



WARNING! Do not lift the Equipment and Basin units together. Detach latches before lifting.



WARNING! Two person lift required for Equipment.



WARNING! The Equipment must be latched to the Basin during use and before moving.



WARNING! Do not position the system so that it is difficult to unplug the system's power cord.



WARNING! Remove all highly combustible material from the treatment room.



WARNING! There is a risk of fire associated with oxygen enrichment during oxygen therapy. Do not use the device or accessories near sparks or open flames.



WARNING! Use only water-based lotions or salves that are oxygen-compatible before and during treatment. Never use petroleum-based or oil-based lotions or salves to avoid the risk of fire and burns.



WARNING! Do not lubricate fittings, connections, hose, or other accessories of the device to avoid the risk of fire and burns.



WARNING! No user serviceable parts inside. Enclosure should only be opened by an authorized service provider.



WARNING! Use only spare parts recommended by the manufacturer to ensure proper function and to avoid the risk of fire and burns.



WARNING! No modification of the equipment is allowed.



WARNING! Oxygen makes it easier for a fire to start and spread. Do not leave the treatment chamber components on bed coverings or chair cushions. If the device is turned on, but not in use; the oxygen will make the materials more flammable. Turn the device off when not in use to prevent oxygen enrichment.



WARNING! Not for use with Flammable anesthetics.



WARNING! Do not smoke or operate this machine near open flames.



WARNING! Smoking during oxygen therapy is dangerous and is likely to result in burns or death. Do not allow smoking or open flames within the same room as the device or any oxygen-carrying accessories.



WARNING! Open flames during oxygen therapy are dangerous and are likely to result in fire or death. Do not allow open flames within 2 m of the device or any oxygen-carrying accessories.



WARNING! Use of accessories, transducers and cables other than those specified or provided by the manufacturer of this equipment could result in increased electromagnetic emissions or decreased electromagnetic immunity of this equipment and result in improper operation.



WARNING! This unit has been designed and tested to meet the requirements of electromagnetic, electrostatic, and radio frequency interference standards. However, the possibility of electromagnetic or other interference may still exist. Relocating the device may help to eliminate the interference.



WARNING! Greater than 22mm Hg of mercury oxygen pressure in chamber may occlude arterial circulation, which may lead to a decrease in local tissue circulation.



WARNING! The electrical source with a hospital grade receptacle with protective earth and ground fault interrupter. Failure may result in electrical shock or burn to the operator or patient.



WARNING! This equipment/system is intended for use by healthcare professionals only. This equipment/system may cause radio interference or may disrupt the operation of nearby equipment. It may be necessary to take mitigation measures, such as re-orienting or relocating the VHT-200 Wound Treatment System or shielding the location.



WARNING! Do not use an alternative power cord with system as it could affect device safety or affect compliance with electromagnetic emissions and immunity. A risk of increased emissions or decreased immunity may result if any additional cables are attached.



WARNING! Move equipment or personal items (e.g., clothing, jewelry) likely to produce static discharges at least five feet from the patient in order to prevent potential ignition of the oxygen rich treatment chamber.



SHOCK HAZARD! Replace fuses only with the same type and rating.



SHOCK HAZARD! To avoid the risk of electric shock, this equipment must only be connected to a supply mains with protective earth.



WARNING! Place any electrical appliance (e.g., television) at least five (5) feet from the patient in order to prevent potential ignition of the oxygen rich treatment chamber.



DANGER! VHT-200 may cause or intensify fire. An oxidizing material may or may not burn itself, but will release oxygen or another oxidizing substance, thereby may cause or contribute to the combustion of another material. If a fire or spark is detected, immediately turn the on/off

switch to the off position, if possible, unplug the equipment from the outlet and evacuate the area.

Precautions

- Exercise special care for the safe and effective use of this device.
- Read the manufacturer's directions before use.
- Misuse of this device can lead to adverse events.
- Exercise caution when handling.
- In case of emergency turn off machine, disconnect power cord from wall outlet to isolate the system from mains power and follow facility emergency protocol.
- Approach bumps perpendicularly.
- When setting up the VHT-200, make sure the power cord is out of the way and not under feet. Do not tangle cords.

Potential Risks and Benefits

The potential risks to health associated with the device are: delayed wound treatment, inflammation/foreign body response, infection, and electrical shock. Oxygen can be delivered to any part of the body at low pressure that is enclosed in a compartment with complete safety, as long as blood flow to and from the area is not compromised by too tight an application of the restricting element used. Any likelihood of injury is minimal. To prevent any such injury, ensure that all directions have been read and followed correctly and that the patient is in a clear state of mind to stop the treatment in the event of experienced pain during the treatment. The benefits of the VHT-200 are: temporary increase in local blood circulation and oxygenation where applied. The benefits outweigh the risks and accelerated wound treatment should be realized shortly after the treatments are started.

Patient Sensitivities

No components in the Disposable Treatment Chamber Kit of the VHT-200 System are made with natural rubber latex.

Questions?

The Vaporox VHT-200 Wound Treatment System and accessories are manufactured by Vaporox, Inc. in Centennial, Colorado. For further information regarding the operation, repair, parts, or maintenance of the VHT-200 System, please contact:

VAPOROX, Inc.

(303) 558-5145

**Attention: Service Department
8375 S. Willow Street
Lone Tree, CO 80124
www.vaporox.com**

Updates to this User Manual are available for download at:
www.vaporox.com/usermanual/

Overview of the VHT-200 System

The VHT-200 is designed for the medical provider to determine the number of cycles and vapor output of the treatments based on his/her experience and professional assessment of the individual patient's medical need.

It consists of:

- Basin with six (6) wheels and four (4) are lockable wheels
- Equipment (Upper unit) with two (2) Handles and power cord (i.e., Disconnect Device)
- Vaporizer
- Control Panel (Touchscreen display)
- Extendable Pole
- Disposable Treatment Chamber Kit (i.e., Applied Part)
 - Hose – with pre-attached connectors
 - Treatment chamber bag
 - Bag support

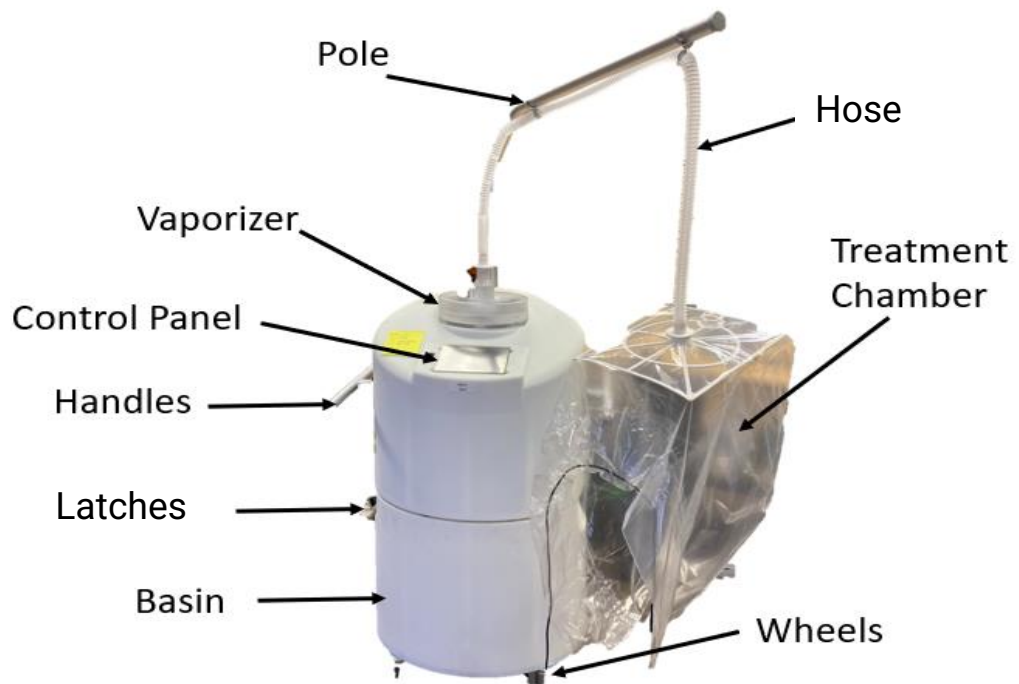

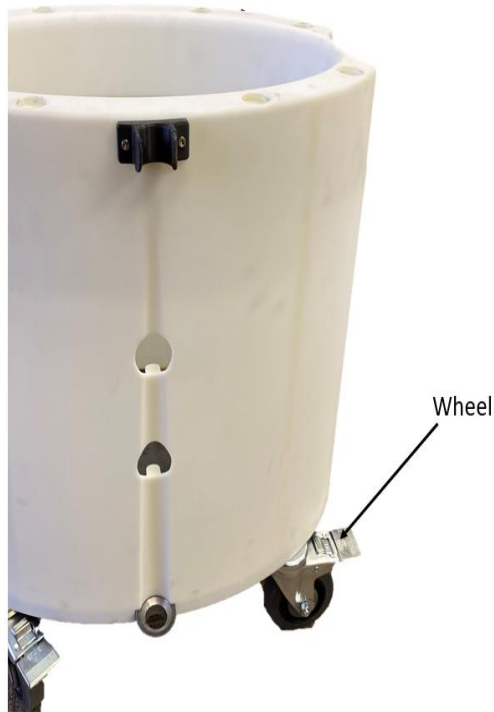

Equipment Description:

The VHT-200 system is a FDA Class II medical device that provides humidified oxygen to open, acute and chronic wounds as an *adjunct* therapy in wound treatment management. The VHT-200 is designed in modules that can be assembled and disassembled for module replacement. The system is mobile but stationary for patient treatment.

The system's primary module is called the Equipment, which includes a control panel and removable power cord. The Equipment is then combined and assembled with its accessories (the Basin, Pole, and Vaporizer) and this full assembly is called the VHT-200 System. The system is used in conjunction with a single-use disposable, called the Disposable Treatment Chamber Kit, which attaches to the Vaporizer. The disposable kit is comprised of several Low-Density Poly Ethelene (LDPE) components; the Treatment Hose, Treatment Chamber Bag, and Bag Support. Once fully assembled, the disposable kit creates a tent like enclosure containing the treatment environment without producing any positive pressure differential by allowing for flow of the air, vapor, and/or oxygen around the wound and then to exit.

When setting the system up for treatment, the patient's wound is placed inside of the treatment chamber. The treatment chamber is designed to NOT be in contact with the wound being treated, whereas the only contact would be incidental during setup or

removal. The only intended patient contact occurs where the chamber is gathered around a healthy, non-wound portion of the patient’s skin or limb.

Once the system and patient have been set up for treatment, the system will deliver several cycles of alternating therapy conditions once treatment has started. Each cycle consists of first applying water vapor to the wound and then switching to deliver oxygen to the wound. The exact amount of water vapor absorbed by the patient’s wound and the rise in oxygen level concentration are dependent on many variables such as the patient size, age, weight, wound grade, position of wound, size of wound, age of wound, local environment, and treatment settings. Therefore, the performance of the device has been predicated on simply improving the wound environment to be greater than the local environment in a way that the performance is proportional to all these variables.

Control Panel:

The control panel is located at the top of the VHT-200 Equipment. It consists of a touchscreen display that allows providers to control the operation of the system. The display includes the default settings whereas the operator can choose to set treatment parameters and monitor treatment.

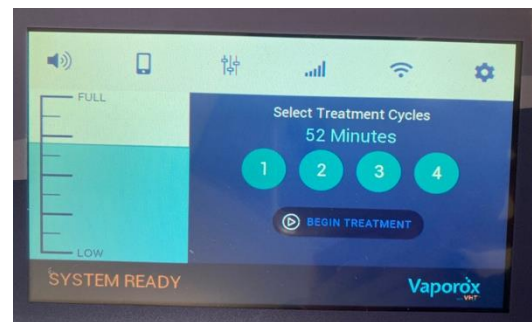

Once the control panel is turned on via the power switch on the left side of the control panel, a Select Treatment Cycles screen is displayed on the touchscreen with the default treatment settings.

Power:

The power cord is connected on the top canister of the VHT-200 (A). Plug the VHT-200 into an A/C outlet.

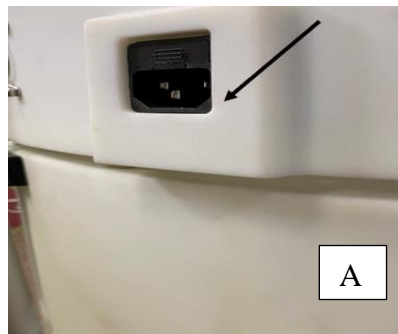

The power switch is on the left-hand side of the control panel (B). Switch the power ON by pressing the switch to “-”.

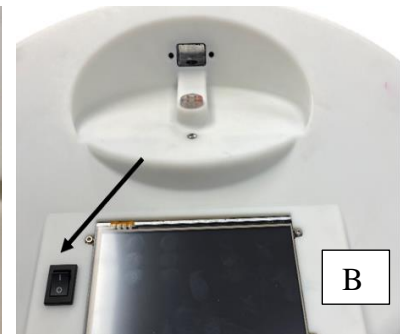



WARNING: No operator serviceable parts inside. Enclosure should only be opened by an authorized service provider.



WARNING! This unit has been designed and tested to meet the requirements of electromagnetic, electrostatic, and radio frequency interference standards. However, the possibility of electromagnetic or other interference may still exist. Relocating the device may help to eliminate the interference.

Preparing for Treatment

- **Main System Setup.** Ensure outer wheels are locked and install the VHT-200 by aligning the System Equipment to the top of the Basin. Lock the two latches on each side to secure the Equipment to the Basin.

NOTE: Per provider's recommendation, the basin may be lined with the treatment chamber bag and used for treatment if the wound cannot be elevated comfortably to the desired height as intended with the full VHT 200 system setup. Refer to Basin Set Up for further directions.



WARNING! Two person lift required for Equipment



WARNING! The Equipment must be latched to the Basin during use and before moving.

- **Power Connection.** Plug in the power cord and re-lock the wheels of the VHT-200



WARNING! Do not lift the Equipment and Basin together. Detach latches before lifting.

once it is positioned into place if it has been moved.

NOTE: When setting up the VHT-200, ensure the power cord is out of the way and not under foot. Do not tangle cords. Ensure that the unit is not placed in a position that will prevent safe disconnection of the power cord.

- **Vaporizer Installation.** Install the vaporizer by ensuring the vaporizer components are connected, or snapped together, and then place the Vaporizer onto the top of the System along the groove until it's snug and no longer will move.

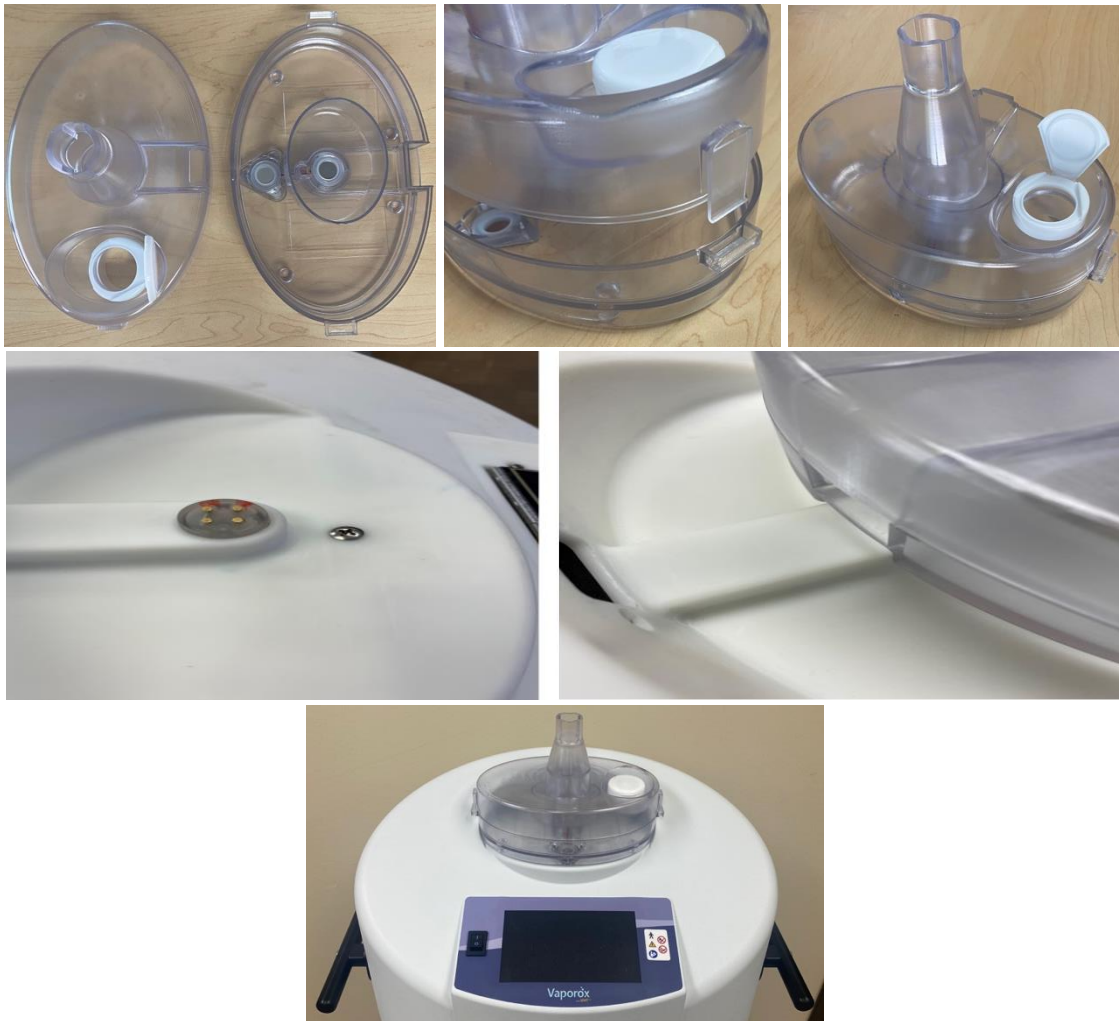

- **Pole Attachment.** Connect the pole to the basin by inserting the conical end first into the pole holder attached to the back of the basin and then snap into the pole clip. To adjust the pole height, loosen the twist-lock and telescope the pole to the desired height and then tighten the twist-lock. To pivot open the pole hinge, press on the incremental pole hinge while opening up the free end of the pole until the poles are perpendicular. The free end of the pole should be parallel to the ground.



WARNING! The pole is intended to support only supporting the treatment chamber and it is not intended to support or stabilize persons.



- **Hanger Attachment.** Attach the hose-hanger clips to the horizontal end of the pole.

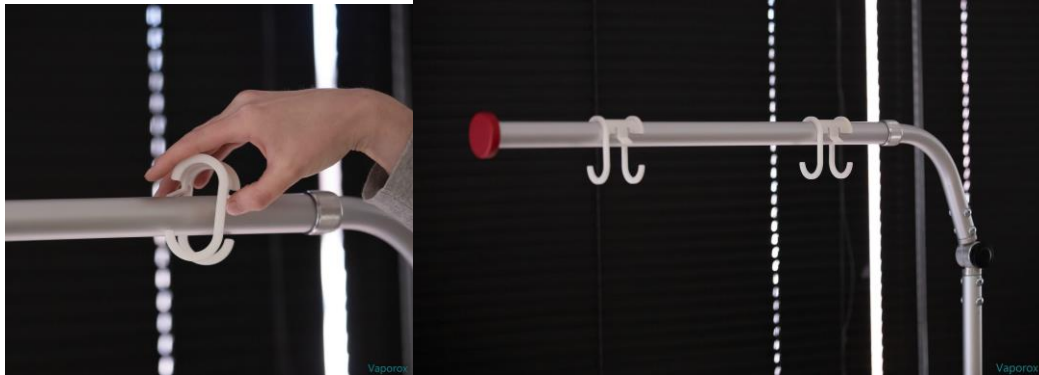

- **Treatment Chamber Setup.** Ensure that all supplies needed for the treatment are in the treatment room. The patient applied part consists of the components in the Disposable Treatment Chamber kit.
 - Disposable Treatment Chamber Kit (components shown below).
 - A1. Hose with pre-attached connectors
 - B1. Treatment chamber bag
 - C1. Bag support

NOTE: All components in the Treatment Chamber Kit are Single Use Only and should be disposed of properly after one use.

NOTE: All treatment chamber kit components are not made with natural rubber latex.

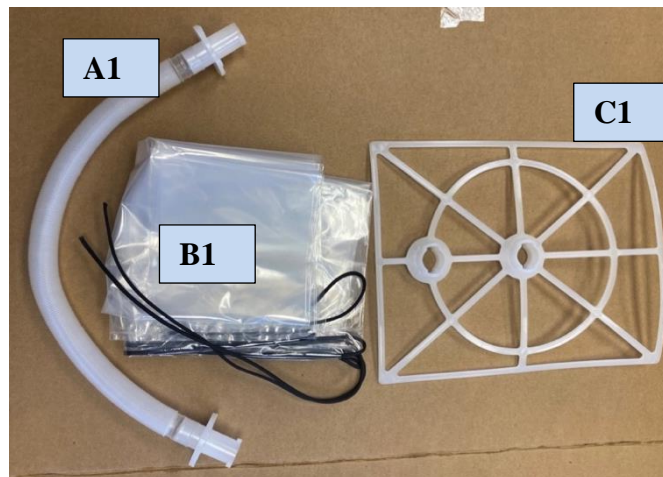

- Sterile water for irrigation, at least 16 fluid ounces.
- c. VHT-200 System and power cord.

- **Vaporizer Fill.** Open the vaporizer cap and fill the vaporizer with sterile water for irrigation to the indicated maximum fill line, or until the fluid level reaches the bottom of the tube where the fluid is poured, as indicated in the image below. Once filled, close the cap until it “clicks”.

NOTE: The system is designed and validated for use with sterile water for irrigation..

NOTE: If the Vaporizer is overfilled, carefully remove the vaporizer from the system, empty in a sink, place the Vaporizer back on the system, and refill to the indicator line.



WARNING! Avoid overfilling the sterile water for irrigation in the Vaporizer.

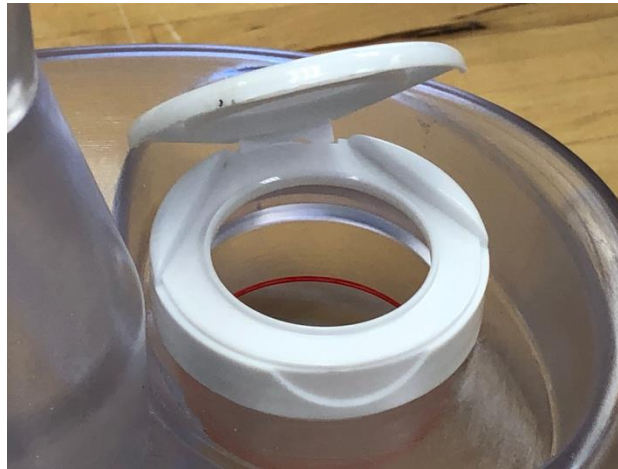

- **Hose Attachment.** Connect one end of the hose into the top of the vaporizer and secure it with a twist and lock motion. Feed the free end of the hose into the hangers attached to the pole and unaccordian the hose as needed for the appropriate length.

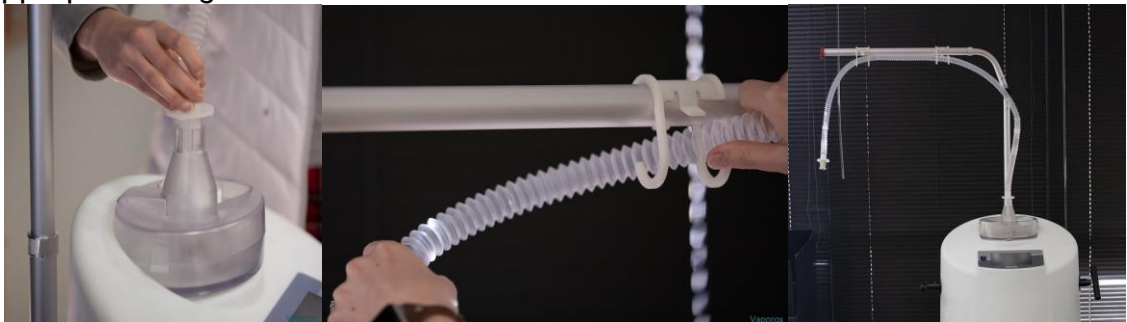

- **Treatment Chamber Setup.** Place the bag support inside the treatment chamber bag to assemble the treatment chamber. Align the bag support holes with the two holes in the bag and pull the bag flush against the bag support. Connect the other end of the hose to the insert.



WARNING! For treatment of wounds, this device should be used under close supervision and direction of a medical provider or professional therapist



WARNING! The device is not intended for any use other than indicated.



WARNING! The treatment kit (hose, connectors, treatment bag and bag support) is single-use only and must be disposed of after treatment is completed.



WARNING! Unattended use of the VHT-200 by children or incapacitated persons may be dangerous.

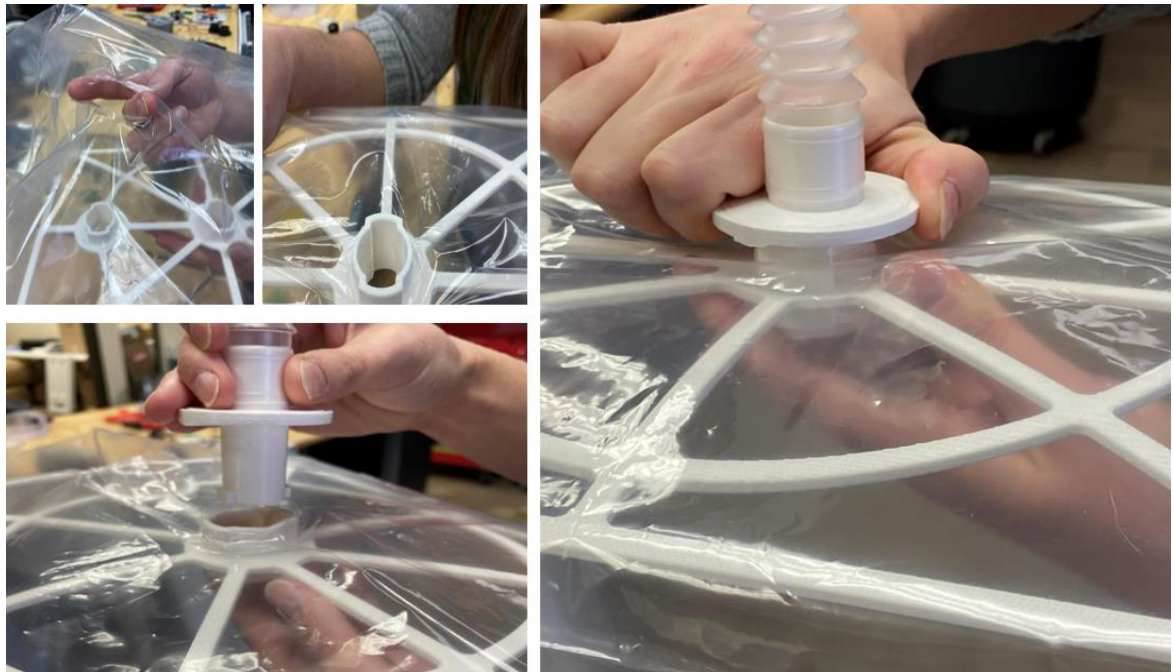

- **Limited Patient Mobility Setup.** An alternative set-up to provide treatment is placement of the disposable treatment chamber and wound area in the basin of the system per the provider's recommendations.
 - Ensure the wheels are locked.
 - Unlock the Top Unit from the Basin as depicted in Preparing for Treatment Step 1 by unhinging the two latches on both sides of the system.
 - With a two-person lift using the metal handles on the side, carefully lift the top System Unit and place it on the floor near the basin.
 - Remove the treatment chamber bag, bag support, and hose from its packaging.
 - Connect the hose to the vaporizer as shown in step 8.
 - Place the bag support into the treatment chamber bag and align holes as shown in step 9.
 - Place treatment chamber assembly into the basin with the black cord and opening of the chamber toward the top of the basin and the bag support holes aligned with the holes in the basin.
 - Attach one end of the hose to the top of the Vaporizer and the other to the to the bag support through the back of the basin.
 - Place wound in the treatment chamber and gently cinch the cord around the patient's leg.
 - Ensure hose connectors are still connected before starting treatment.



Starting Treatment

The VHT-200 has a default treatment setting. This setting is made up of four cycles, each delivering vapor followed by oxygen, and treatment under this setting takes approximately 56 minutes to complete. Adjustments can be made to the default settings under the prescribing clinician's discretion.

1. Confirm vaporizer is filled with sterile water for irrigation and the device is powered on.
2. Set vaporizer flow control to the desired level.

3. Ensure attending physician undresses and debrides the wound. The wound base must be clean and dry.
4. Allow patient to be comfortably seated with support under the treatment leg allowing it to be extended forward.

NOTE: Ensure the outer wheels are locked when the device is in use to prevent movement when placing the patient's limb in the device.

5. Guide patient's foot into the treatment chamber. Ensure that the wound is completely inside the treatment chamber and pull the cord snug around the patient's limb. Cinch the bag to maintain vapor in the bag but not too tight on the patient's limb. Adjust the pole and treatment chamber to align to the foot.



WARNING! Do not tie or knot the draw string on treatment bag.







6. Verify that the patient is comfortable and can maintain position for length of treatment.
7. Select the number of treatment and then press "Begin Treatment". The default setting for each cycle is 14 minutes with the default treatment time being 56 minutes to complete four complete cycles.



8. Begin treatment. The treatment and system may be halted for any reason by touching the Pause button (||) or Stop button (⊞) on the screen.
9. To resume treatment after pausing, ensure the patient limb and bag are positioned as described in steps 5 & 6 of *Starting Treatment*, and press the resume button (▶).

NOTE: The System can be safely powered off at any time by using the On/Off switch to the left of the Display screen.

	WARNING: If patient shows any discomfort or pain during the treatment, stop the treatment immediately.
	WARNING: Greater than 22mm Hg of mercury oxygen pressure in chamber may occlude arterial circulation, which may lead to a decrease in local tissue circulation.
	DANGER: Equipment may cause or intensify fire. An oxidizing material may or may not burn itself, but will release oxygen or another oxidizing substance, thereby causing or contributing to the combustion of another material. If a fire or spark is detected, immediately turn the on/off switch to the off position, if possible, unplug the equipment from the outlet and evacuate the area.
	Do not smoke near the system.

After Treatment Care

1. When treatment is completed, loosen the bag cord around patient's leg and help guide the patient's foot out of the treatment chamber.
2. Carefully rinse the patient's wound with sterile water for irrigation for at least thirty seconds.
3. Carefully dry off patient's foot of any remaining moisture.
4. Notify the attending physician of the completed treatment.
5. Disconnect the hose and treatment chamber. Dispose of these components in an appropriately labeled waste system such as Bio-waste. Dispose of the treatment chamber components in accordance with local and federal laws. Disposal must be in a sanitary manner as improper disposal may lead to cross contamination.

	WARNING: Always dispose of the Disposable Treatment Chamber accessories immediately as a single use and do not reuse disposables.
---	--

6. Disconnect the power cord from the power outlet.
7. At the pole hinge, press and lower the pole arm so that the two poles are parallel to each other. With the twist lock, unlock and retract the pole length to prepare the pole for storage. The folded pole can be stored attached to the basin.

	WARNING: Retract the pole when not in use.
---	---

8. Follow Daily Cleaning Process.

Cleaning of the VHT-200

The **VHT-200** should receive regular cleaning to prevent bacterial growth.

After completion of every treatment, disconnect the hose from the vaporizer and dispose of treatment chamber bag, hose, and bag support into a Bio-Waste container.

Equipment, Basin, Pole Cleaning Solutions

- Clorox® Disinfecting wipes
- Sani-Cloth Plus Germicidal Disposable Cloth
- Mild Soap and water.

Equipment, Basin, Pole Cleaning Process

1. Thoroughly wipe all outer surfaces of the system with one recommended cleaning solution as listed above and allow to dry between treatments.
2. If the Basin was used for the Limited Patient Mobility setup, thoroughly wipe all inside surface of the basin with recommended cleaning solutions as listed above and allow to dry between treatments.

Vaporizer Cleaning Solutions

- Mild dishwashing detergent
Note: Dawn® Ultra Dishwashing Liquid was used in the cleaning validation.

Vaporizer Cleaning Process

1. Wear medical grade gloves while handling and cleaning the Vaporizer and Vaporizer components.
2. At the end of every day of use, remove the Vaporizer from the Equipment.
3. The Vaporizer is composed of three components as shown below.

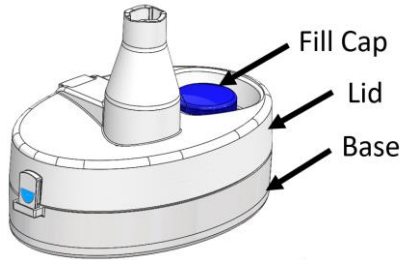

4. Disassemble the three Vaporizer components by:
- a. Push in on both tabs of the Vaporizer lid.

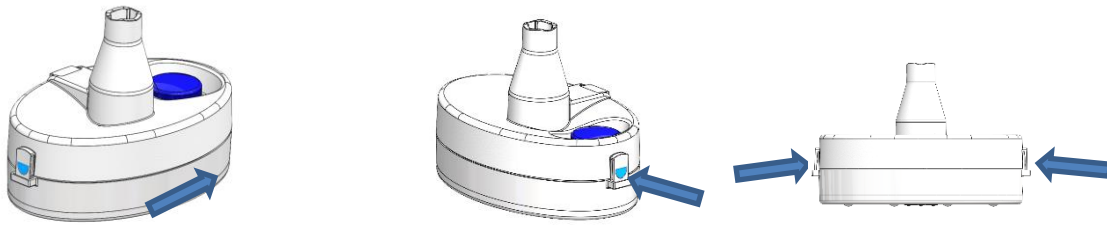

- b. With both tabs pushed in, pull and detach the lid of the Vaporizer from the base.

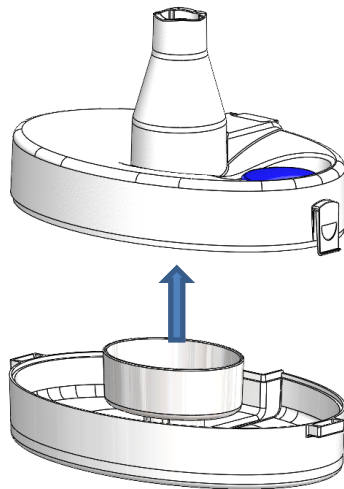

- c. Unthread and remove fill cap from vaporizer lid, and drain remaining liquid into a sink.

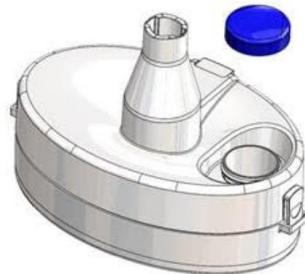

5. Clean each Vaporizer component separately as described below.

6. Mix 1 teaspoon (5 milliliters) mild dishwashing detergent in 1 gallon (3.8 liters) of room-temperature (20-25°C) utility (tap) water.
7. Submerge vaporizer lid and fill cap in mild dishwashing detergent solution in a basin. Open fill cap hinge and brush all water-contacting surfaces of the vaporizer with a soft, nylon brush, paying special attention to the hinge and threading of the fill cap as well as any crevices, recesses, lumens, openings, or gaskets in the vaporizer lid. Brush for a minimum of 1 minute.
8. Dampen a lint-free cloth (not dripping) with the mild dishwashing detergent solution and wipe the interior water-contacting surfaces and exterior of the vaporizer base, paying special attention to any crevices, recesses, lumens, openings or gaskets. Wipe, for a minimum of 1 minute. Note: Do not submerge vaporizer base containing electronics in liquid.
9. Brush all interior water-contacting surfaces of the vaporizer base with a soft, nylon brush, paying special attention to any crevices, recesses, lumens, openings, or gaskets. Brush for a minimum of 1 minute. Note: Do not submerge vaporizer base containing electronics in liquid.
10. Rinse all components of vaporizer lid and base, including separate fill cap, under running, room-temperature (20-25°C) utility (tap) water while rotating and turning the components for 1 minute each to remove detergent residue. Note: Do not submerge vaporizer base containing electronics in liquid.
11. Rinse all components of vaporizer lid and base, including separate fill cap, with room-temperature (20-25°C) sterile water for irrigation (i.e., treatment water) in a sink while rotating and turning the components for 15 seconds each. Note: Do not submerge vaporizer base containing electronics in liquid.
12. Apply 70% v/v Isopropyl Alcohol (IPA) by spray to saturate the interior water-contacting surfaces and exterior of the vaporizer lid and base, including separate fill cap, paying special attention to the hinge and threading of the fill cap as well as any crevices, recesses, lumens, openings, or gaskets in the vaporizer lid and base.
13. Allow surfaces to remain wet with IPA for a minimum of ten (10) minutes. Re-apply 70% IPA if surfaces become dry, paying special attention to the hinge and threading of the fill cap as well as any crevices, recesses, lumens, openings, or gaskets in the vaporizer lid and base.
14. Rinse all components of vaporizer lid and base, including separate fill cap, with room-temperature (20-25°C) sterile water for irrigation (i.e., treatment water) in a sink while rotating and turning the components for 15 seconds each.
15. Shake vaporizer lid and base, including separate fill cap, to remove excess liquid, dry with lint-free cloth, and spray apply 70% IPA to, paying special attention to the hinge and threading of the fill cap as well as any crevices, recesses, lumens, openings, or gaskets in the vaporizer lid and base the challenge areas. Set the components on a flat surface covered with clean and dry lint-free cloths in the orientation with inner water-contacting surfaces facing downwards towards the cloths. Let the components air-dry for a minimum of 2 hours.

16. Perform a visual inspection, paying special attention to the hinge and threading of the fill cap as well as any crevices, recesses, lumens, openings, or gaskets in the vaporizer lid and base. Inspect the device for any signs of soil and confirm device has dried before reassembly of vaporizer lid and fill cap with base. If soil is observed, repeat steps 6 – 14. If any moisture is observed, take care to dry affected areas completely with a lint-free cloth.

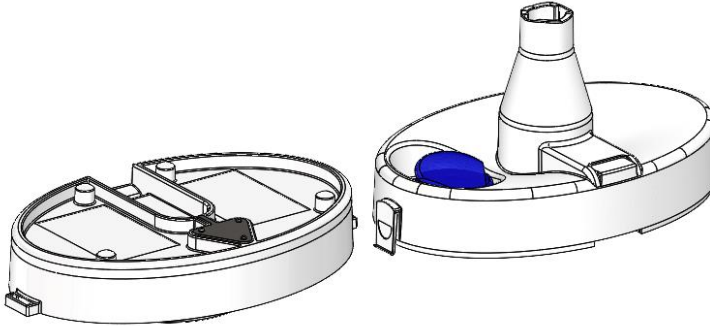

17. Once dry, visually inspect the Vaporizer components for damage or degradation. If any area appears to be damaged or degraded, do not use components and contact Vaporox customer support for a replacement.
18. Reassemble the Vaporizer components by aligning the end snap features and gently pressing the components together until an audible snap is either heard or felt.

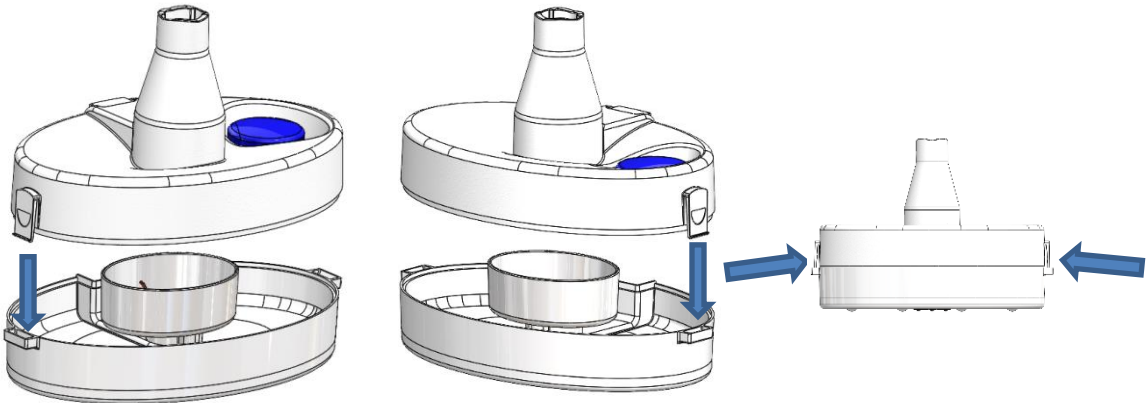

Transport & Storage

When moving the VHT-200 system between rooms or within the office environment, the user needs to ensure the following:

1. The vaporizer has been emptied of any water.
2. Ensure the Equipment Module is latched to the Basin via the two latches located on the sides of the Basin, as shown in the *Preparing for Treatment* section.

3. Fold the Pole down by pressing the hub in and then folding the arm down until it is parallel.
4. Unlock all wheels before moving.
5. Next, the user may move the device, pushing from either side using the handles.
6. When the machine is at its final location, lock at least two castors, reposition the Bag Pole as desired, and prepare for Treatment.

NOTE: Do not push the device from the front or back direction, only push from the left or right side using the handles.

The VHT-200 is designed to be stored in a clinical setting or treatment room.

NOTE: Ensure wheel locks are set when in storage.

Maintenance

No regular maintenance, other than surface cleaning, of the VHT-200 is needed by the user. Vaporox, Inc. or an authorized service provider will perform all other maintenance and service duties not referenced in this manual.

Expected service life of the VHT-200 System is one year. The equipment and accessories must be properly disposed of in accordance with local and federal laws.



WARNING: No user serviceable parts are inside the VHT 200. Equipment enclosure should only be opened by an authorized service provider.



NOTE: Periodically running the VHT-200 System is required to preserve the life of the oxygen concentrator. Run the O2 Maintenance function once per week (if the system has not been used) to preserve the life of the oxygen concentrator.

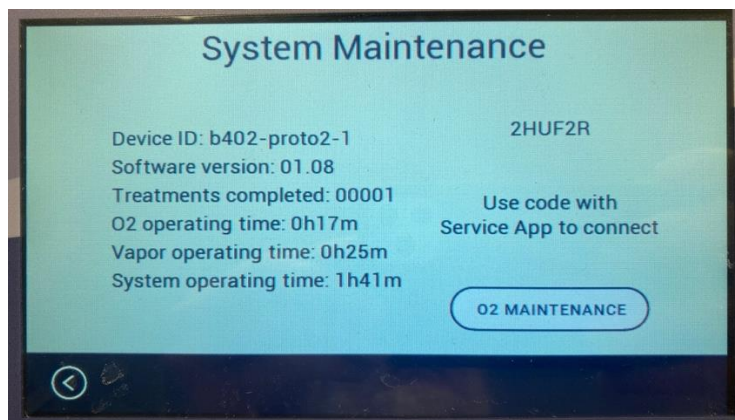

NOTE: Periodically check the power cord for damage (fraying, cuts, scrapes etc.).



NOTE: No lubricants other than those recommended by the manufacturer are to be used.

Troubleshooting

Prior to contacting Vaporox Technical Support, please read the troubleshooting table below.

Symptom	Possible Cause	Corrective Action
No Power VHT-200 does not turn on	VHT-200 not connected to power source	Ensure the power cord is properly connected to power source and the VHT-200.
	No power at outlet	Check the outlet by connecting to another electrical unit known to be working. If unit does not work, relocate VHT-200 to a functioning electrical outlet.
	Power switch turned OFF	Ensure the power switch is in the “on” position.
	Blown fuse	Replace fuses (see section for Fuse Replacement).
No oxygen flow (NOTE: Not visible as vapor)	Compressor malfunction	Contact Vaporox Technical Services.
No Vapor	Loose hose connection	Ensure hose is inserted snugly into the vaporizer.
	Vaporizer not properly installed	Confirm the Vaporizer is connected to the Top Equipment Unit with a snug fit.
	Vaporizer empty	Confirm the Vaporizer still has sterile water for irrigation in it. Remove the cap to observe level if needed.
	Vaporizer malfunction	Contact Vaporox Technical Services.
VHT-200 is not responding	Touchscreen malfunction	Turn power OFF and turn power back ON to reset the system.

User Interface Fault Messages:

Symptom Displayed	Possible Cause	Corrective Action
Refill Fluid	Vaporizer empty or does not have enough sterile water for irrigation. to perform a treatment.	Refill the vaporizer according to Treatment Setup Instructions.
Vaporizer Not Installed	No vaporizer located on the machine or vaporizer connection to the Equipment was interrupted or jostled.	Remove and replace the vaporizer ensuring it is seated fully on top of the Equipment Module.
System Fault	Unexpected operation or software condition has occurred internally to the VHT-200 System.	Power cycle the device and see if the fault clears, if it does not, call Vaporox, Inc Tech support for help trouble shooting.
Low Oxygen Warning (oxygen level between 85 and 70%)	Oxygen Concentrator is failing, compressor is failing, O2 Sensor is bad.	Contact technical support. NOTE: Device is ok to continue to use on patients.
Low Oxygen Fault (oxygen < 70%)	Oxygen Concentrator is failing, compressor is failing, O2 Sensor is bad.	Contact technical support. Device will not operate.
VHT-200 filter needs to be changed	Device filter will need service soon.	Contact technical support. NOTE: Device is ok to continue to use on patients.
VHT-200 filter has expired	Device filter needs service.	Contact technical support. Device will not operate.

Replacement of any failed module of the VHT-200 system starts by contacting Vaporox, Inc. and requesting for a replacement item and having it shipped to the user. This applies to the replacement of: Vaporizer, Pole, Basin, or Power Cord.

When physically replacing the component, the removal of the item is performed in the reverse manner as the instructions listed in the Preparing for Treatment section. Then, when the replacement item is received, the system shall be set back up in the exact same manner following the instructions in the Preparing for Treatment section.

Contacting Vaporox Technical Service

If you encounter problems troubleshooting the VHT-200 that you cannot resolve, contact Vaporox Technical Services at (303)558-5145.

Fuse Replacement

The power outlet on the side of the VHT-200 houses a Fuse Compartment, which contains two active 250V / 10A fuses.

1. To gain access to the fuses, turn off the power and disconnect the AC power cord from the wall.
2. With a small screwdriver, gently remove the fuse compartment on the power module and replace the bad fuse.

NOTE: A new fuse may be stored in the small sliding compartment of the fuse holder. Always keep a spare fuse in the compartment to ensure a replacement is readily available.



3. Insert the fuse holder into the power module at the back of the VHT-200.

Filter Replacement

The HEPA filter within the VHT-200 Equipment will be replaced as required by Vaporox, Inc. or an authorized service provider.

WARRANTY

Vaporox Limited Warranty (U.S. Customers Only)

A. This Limited Warranty provides the following assurance to the purchaser of Vaporox Products, hereafter referred to as "Equipment":

(1) Should the Equipment fail to function within normal tolerances due to a defect in materials or workmanship within a period of one (1) year, commencing with the delivery of the Equipment to the purchaser, Vaporox will at its option: (a) repair or replace any part or parts of the Equipment; (b) issue a credit to the purchaser equal to the Purchase Price, as defined in Subsection A (2), against the purchase of the replacement Equipment or (c) provide a functionally comparable replacement Equipment at no charge.

(2) As used herein, Purchase Price shall mean the lesser of the net invoiced price of the original, or current functionally comparable, or replacement Equipment.

B. To qualify for Limited Warranty set forth in Section A (1), the following conditions must be met:

(1) The Equipment must be returned to Vaporox within thirty (30) days after discovery of the defect, (Vaporox may, at its option, repair the Equipment on site).

(2) The Equipment must not have been repaired or altered outside of Vaporox factory in any way which, in the judgment of Vaporox affects its stability and reliability. The Equipment must not have been subjected to misuse, abuse or accident.

C. This Limited Warranty is limited to its express terms. In particular:

(1) Except as expressly provided by this Limited Warranty, VAPOROX IS NOT RESPONSIBLE FOR ANY DIRECT, INCIDENTAL OR CONSEQUENTIAL DAMAGES BASED ON ANY DEFECT, FAILURE OR MALFUNCTION OF THE EQUIPMENT, WHETHER THE CLAIM IS BASED ON WARRANTY, CONTRACT, TORT OR OTHERWISE.

(2) This Limited Warranty is made only to the purchaser of the Equipment. AS TO ALL OTHERS, VAPOROX MAKES NO WARRANTY, EXPRESS OR IMPLIED, INCLUDING, BUT NOT LIMITED TO, ANY IMPLIED WARRANTY OF MERCHANTABILITY OR FITNESS FOR A PARTICULAR PURPOSE WHETHER ARISING FROM STATUTE, COMMON LAW, CUSTOM OR OTHERWISE. NO EXPRESS OR IMPLIED WARRANTY TO THE PATIENT SHALL EXTEND BEYOND THE PERIOD SPECIFIED IN A (1) ABOVE. THIS LIMITED WARRANTY SHALL BE THE EXCLUSIVE REMEDY AVAILABLE TO ANY PERSON.

(3) The exclusions and limitations set out above are not intended to and should not be construed so as to contravene mandatory provisions of applicable law. If any part or term of this Limited Warranty is held to be illegal, unenforceable or in conflict with applicable law by a court of competent jurisdiction, the validity of the remaining portions of the Limited Warranty shall not be affected, and all rights and obligations shall be construed and enforced as if this Limited Warranty did not contain the particular part or term held to be invalid. This Limited Warranty gives the purchaser specific legal rights. The purchaser may also have other rights which vary from state to state.

(4) No person has any authority to bind Vaporox to any representation, condition or warranty except this Limited Warranty.

*This Limited Warranty is provided by Vaporox, Inc. 7012 S. Revere Pkwy, Ste 100, Centennial, CO 80112, USA. It applies only in the United States. Areas outside the United States should contact their local Vaporox representative for exact terms of the Limited Warranty.